

BD FACSAria II



Helping all people
live healthy lives

Let the BD FACSAria II
accompany your best performance ever

Meet the new BD FACSAria II high-speed, fixed-alignment cuvette cell sorter.

The first generation BD FACSAria™ system brought the complex world of cell sorting to a broader audience of researchers. Now the new BD FACSAria II system makes cell sorting even easier and more accessible.

Designed with input from customers around the world, the new BD FACSAria II improves ease of use, flexibility, and aseptic capability to make it simply the best choice for consistent results in sorting across a broad range of applications.

The BD FACSAria II incorporates the unique fixed alignment technology that revolutionized cell sorting over five years ago with the introduction of the BD FACSAria. Fixed alignment minimizes startup time and improves reproducibility. Gel coupling to the objective lens improves collection efficiency and increases sensitivity and resolution needed for multicolor sorting applications.

The BD FACSAria II advances cell sorting with multiple improvements including:

New fluidics and nozzle designs

A new fluidics design improves aseptic setup and cleaning. New nozzle sizes enable a wide range of particles to be sorted and new nozzle design allows for reproducible insertions. Software wizards and automation simplify aseptic sort setup, drop delay determination, and clog detection.

Better workflow and productivity

The BD FACSAria II also raises the bar on ease of use to improve both workflow and productivity with improvements across the platform. For example, a universal sort tube collection mount now makes it easier to insert and remove tube holders. In addition, software improvements dramatically cut the time spent on cytometer setup, adjustment, and maintenance.

New 375-nm Near UV laser

The 375-nm Near UV laser option is available to expand the range of application choices. The beam geometry is optimized for most hematopoietic stem cells. The top hat design of the 375-nm Near UV laser triples the amount of light at the sample intercept. The 375-nm Near UV laser can be operated together with the red and blue lasers.

Upgrades from BD FACSAria to BD FACSAria II

Packages will be available to field upgrade BD FACSAria instruments to the capabilities of the BD FACSAria II.

Discover what makes the BD FACSAria II the platform of choice worldwide—then let it accompany your best performance ever.

First II Deliver

New fluidics design enables easy aseptic setup and effective cleaning.

The fluidics system moves particles from the sample injection chamber through the cuvette flow cell for interrogation and sorting into a collection device.

Aseptic setup and cleaning are achieved through a new fluidics design that is both effective and easy to use. It features integrated valve manifolds, and a streamlined fluidics path, to allow for improved aseptic sort setup. In addition, new software wizards make aseptic sort setup easy.



Fluidics cart

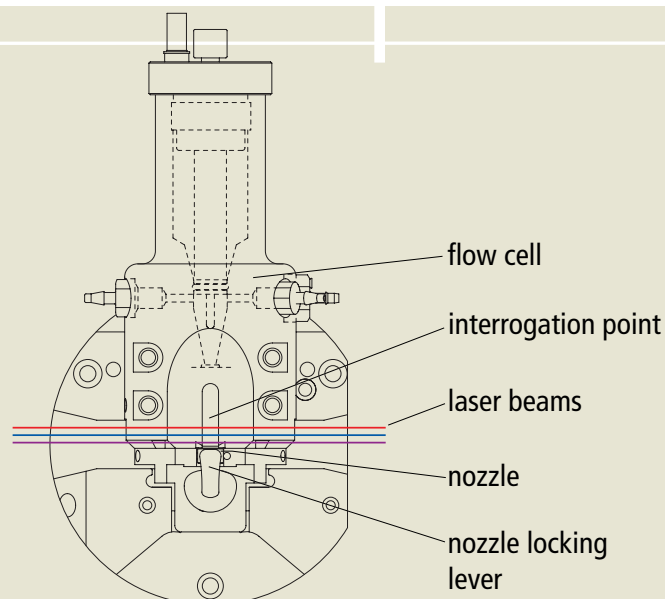

Cuvette flow cell

Hydrodynamic focusing within the flow cell forces particles through the cuvette in a single-file stream where laser light intercepts the stream at the sample interrogation point. The unique flow cell design permits particles to flow through the cuvette at a low velocity, allowing longer exposure to laser energy. This ensures optimal resolution and sensitivity even at high speed sort settings. After passing through the cuvette, the stream accelerates through the nozzle and droplets are formed for sorting.

**The heart of a flow cytometer—
the gel-coupled cuvette flow cell**

The gel-coupled cuvette flow cell is where the sample is interrogated and measurements are performed. The BD FACSAria was the first cell sorter with a flow cell in true fixed alignment with the laser and gel coupled to the collection optics. Fixed alignment of the flow cell and laser helps to ensure that the laser is precisely focused on the sample stream and that each of the lasers can generate the greatest amount of signal.

Fixed alignment minimizes startup time, improves experiment-to-experiment reproducibility, and enables automated daily quality control. Gel coupling to the objective lens improves collection efficiency and increases sensitivity and resolution needed for multi-color applications. This design enables multicolor sensitivity even at high-speed sort settings. Since particle interrogation occurs above the nozzle, insertion and removal of the nozzle can occur without realigning the optics or the fluid stream.

The Fluidics Cart

A separate fluidics cart supplies sheath and cleaning fluids and collects waste from the cytometer. The self-contained fluidics cart supplies the air pressure and vacuum needed to achieve pressure from 5 to 75 psi to accommodate a variety of cell sorting applications. Air pressure is adjusted within BD FACSDiva™ software.

The fluidics cart holds a 10-L stainless steel sheath tank, a 5-L stainless steel ethanol shutdown tank, a 10-L waste container, and three 5-L auxiliary cleaning fluid containers. The stainless steel sheath tank can be autoclaved for aseptic cleaning. The cart is typically positioned directly under or to the left of the cytometer.

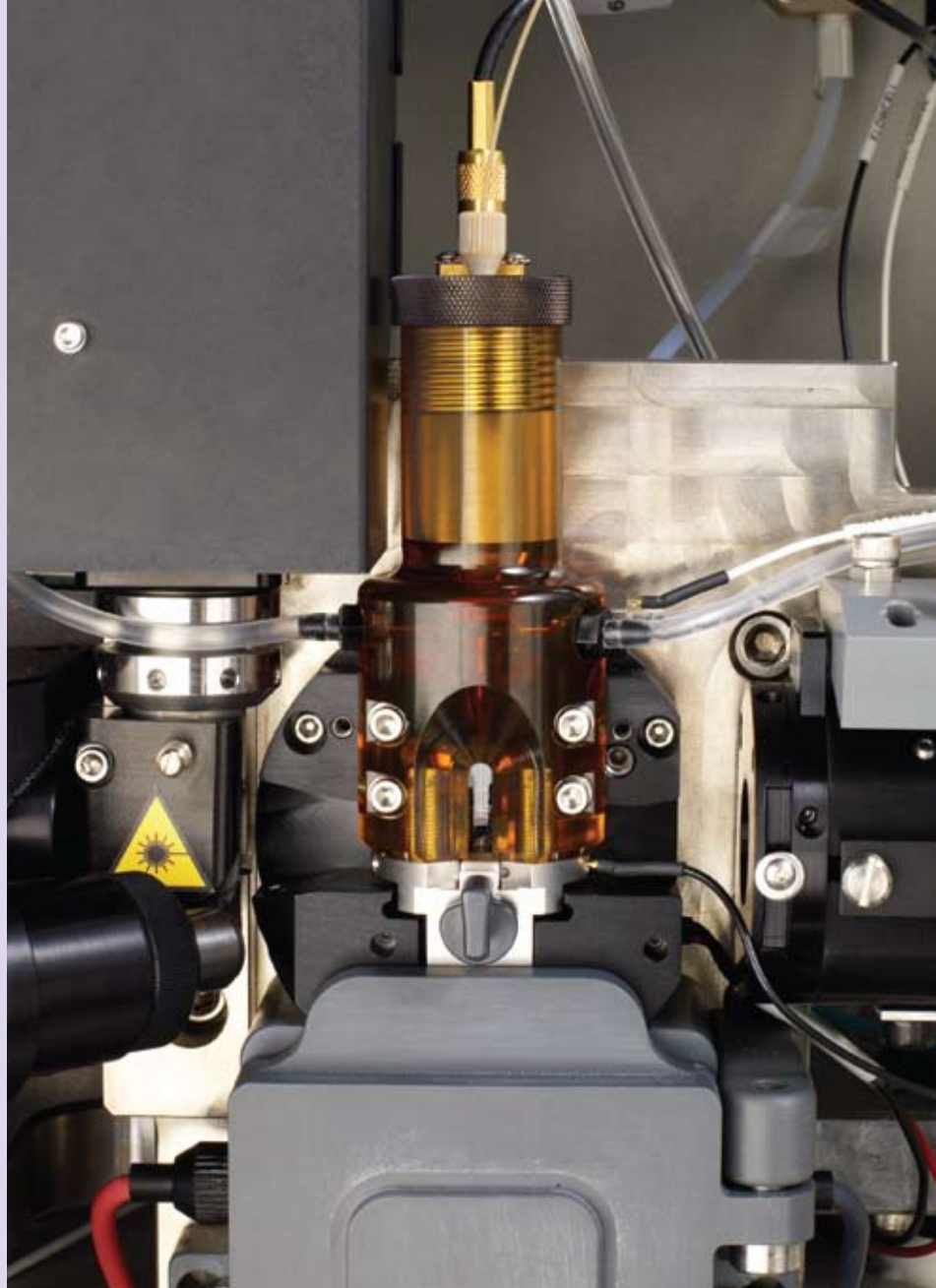

Cuvette flow cell and nozzle



BD Accudrop Technology

Patented BD Accudrop™ technology makes it easy to determine an accurate drop-delay value. Drop delay determination is now easier due to software automation.



Software display of stream breakoff

After the drop delay is calculated, the system automatically adjusts to maintain a constant breakoff, dubbed the Sweet Spot. If a clog is detected, the system stops the sort and protects the collection tubes.

Committed **II** Advance

Aerosol management is engineered into the system.

After leaving the nozzle, particles pass through the sort block where they are deflected into a collection device in the sort collection chamber. The sort block houses the high-voltage deflection plates used to deflect side streams during sorting. A novel deflection plate design fixes plates in position for more efficient and reproducible deflection.

The aspirator and aspirator drawer are also housed in the sort block. The aspirator drawer keeps the sort collection tubes covered until sorting begins and automatically closes to protect sort collection tubes when the Sweet Spot is on and a clog is detected.

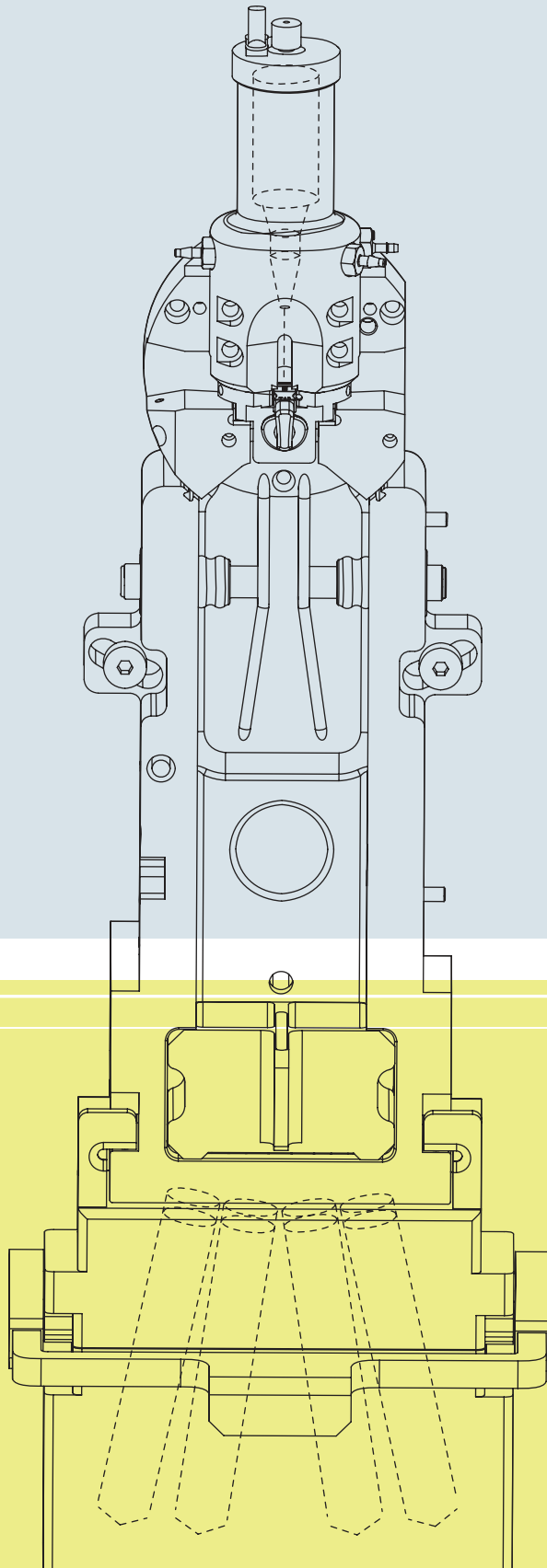

Aerosol management

Engineered with aerosol management in mind, the BD FACSAria II features an enclosed pathway from the sample injection chamber to the sort collection tubes. For an added level of aerosol management, the BD™ Aerosol Management Option (AMO) evacuates the sort collection chamber and traps aerosolized particles during sorting.

Sample injection chamber

The sample injection chamber is where the sample is introduced into the flow cytometer. During acquisition, the chamber is pressurized, forcing the sample to the cuvette flow cell. Sample injection chamber temperature control and agitation are standard with the BD FACSAria II cell sorter. The BD FACSDiva software controls both sample agitation and temperature settings.

After a sample tube is run, both the inside and outside of the sample injection tubing are flushed to minimize carryover. A variety of tube holders are provided, from 15-mL centrifuge tubes to 1.0-mL microtubes. New 35- and 50-micron sample line filters minimize clogging during a sort.

Sort collection chamber

The new universal mount in the sort collection chamber makes inserting the tube holders easier. This design is more robust and helps maintain aseptic conditions. Temperature control for both sort collection tubes and plates is available as an option.

Sort collection chamber

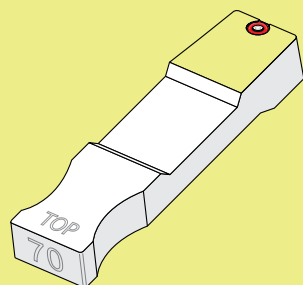
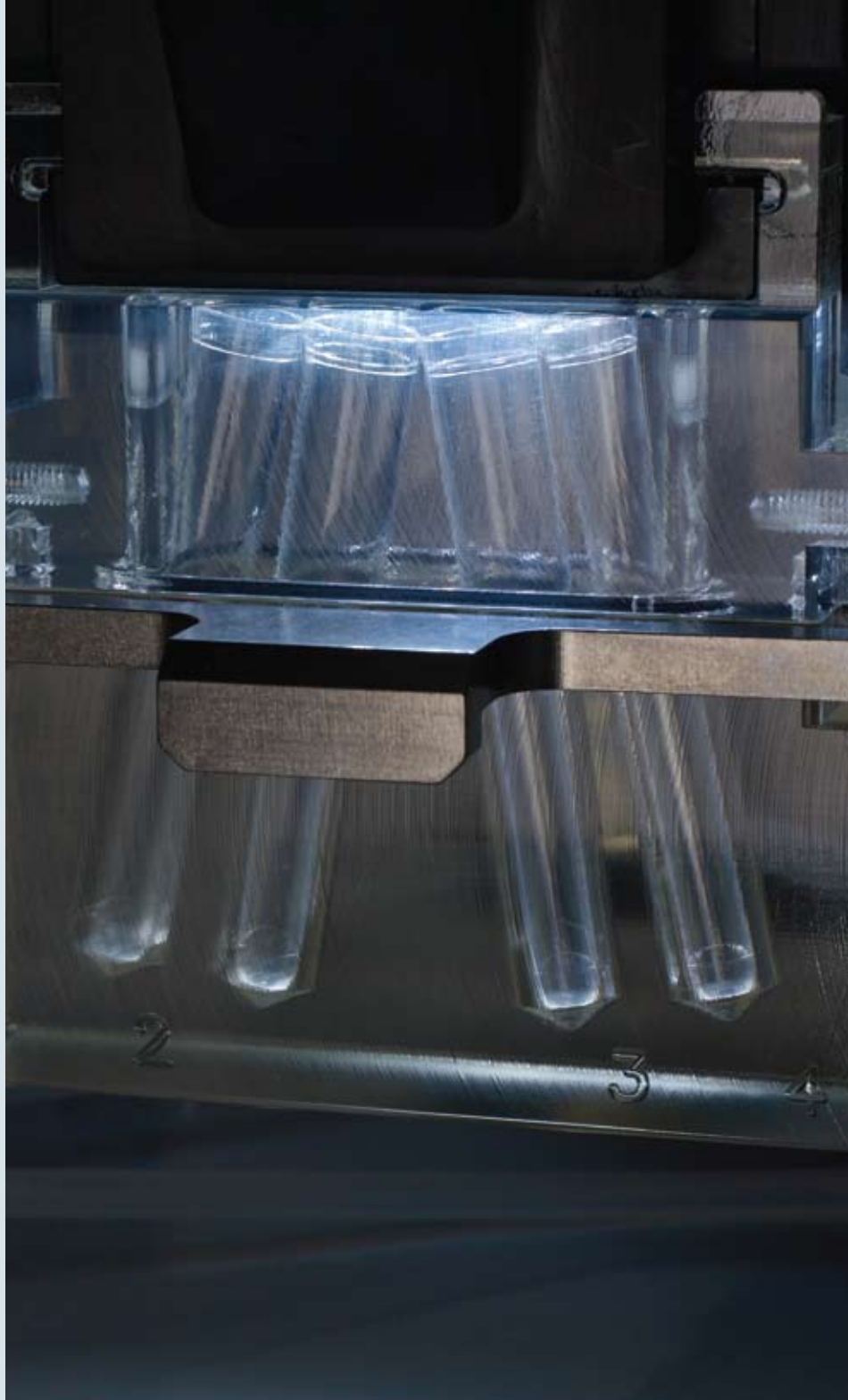
**Nozzle selection and design**

An expanded set of nozzles lets users sort a wide range of particle sizes. Four nozzle sizes are supported: 70, 85, 100, and 130 microns. An improved nozzle insertion design offers tight registration for a secure fit. This means a reproducible drop profile after every insertion, allowing for reproducible instrument setup. Nozzles are readily accessible and easy to change. Software enhancements include a nozzle-specific sort setup feature that matches pressure settings to the nozzle in use.

More **II** See

Innovative optics design increases multicolor detection and efficiency.

Innovative designs for both the excitation optics and collection optics reduce excitation losses and dramatically improve collection efficiency.

The optical design allows for the use of lower powered, air cooled, and solid state lasers for efficiency without sacrificing sensitivity or resolution. No special power or cooling is needed.

Excitation optics

The excitation optics consist of lasers, fiber optic cables, beam-shaping prisms, and an achromatic focusing lens. Fiber optics precisely direct the laser light into beam-shaping prisms that transmit the laser light into a focusing lens. The lens focuses the laser light into the gel-coupled cuvette flow cell. Since the optical pathway and the sample core stream are fixed, alignment is constant from day to day.

Collection optics

The collection optics are set up in octagon- and trigon-shaped arrays that maximize signal detection from each laser. This is accomplished by transmitting the highest wavelengths to the first photomultiplier tube (PMT), and reflecting lower wavelengths to the next PMT through a series of longpass dichroic mirrors. Bandpass filters in front of each PMT allow fine-tuning of the spectral wavelengths that need to be collected.

This design is based on the principle that light reflection is more efficient than light transmission. Emitted light travels to each PMT detector via reflection and is transmitted through only two pieces of glass to reach the detector. This greatly increases sensitivity and resolution for each color in a multicolor panel.

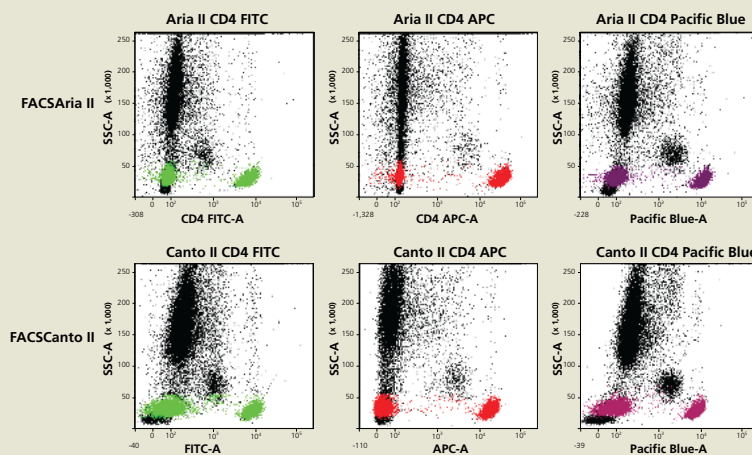

Platform comparison using CD4

Comparison of whole blood stained with single-color CD4 FITC, CD4 APC, and CD4 Pacific Blue™ and run on both the BD FACS Aria II and BD FACSCanto™ II systems. The BD FACS Aria II was set for high-speed sorting (70 psi and 90 kHz) and both instruments were set up using BD Cytometer Setup and Tracking software.



Excitation optics focus the 488-nm, 633-nm, and 405-nm laser beams

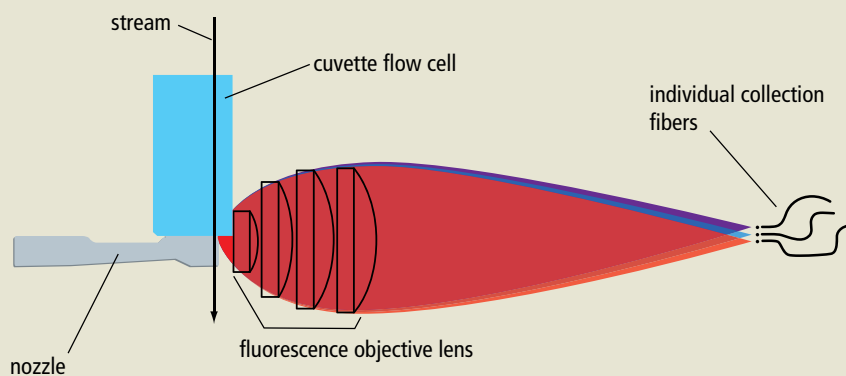

Gel-coupled cuvette flow cell and fluorescence objective lens assembly
 The cuvette is gel coupled to the fluorescence objective lens to transmit the greatest amount of emitted light from the interrogation point to the collection optics. The lens focuses fluorescent light emitted at each of the laser interrogation points onto individual collection fibers. These fibers transfer the emitted light to the collection optics.

Able **II** Perform

Detects up to 15 parameters simultaneously for multicolor flexibility.

For many users, the capability of an advanced cell sorter is defined by its flexibility, which in turn is defined by the number of parameters that can be detected simultaneously. To provide maximum flexibility, the BD FACSAria II cell sorter can be configured with up to four air-cooled, solid state lasers and can detect up to 15 parameters simultaneously—13 fluorescent markers and two scatter parameters when fully equipped.

A standard system is equipped with an octagon containing six PMTs that detect light from the 488-nm (blue) laser, and a trigon containing two PMTs that detect light from the 633-nm (red) laser. The third laser option adds an additional trigon containing two PMTs to detect light from the 405-nm (violet) or 375-nm (Near UV) lasers. Standard instruments can be configured with all four lasers.

375-nm Near UV Laser

The 375-nm Near UV laser option is available to expand the range of application choices. Measuring only $19 \times 7 \times 7$ cm, the fully-housed 375-nm laser fits in the small space immediately left of the flow cell. The laser produces a 10-mW focused beam to illuminate the cells in the flow cell without the aid of fiber optics.

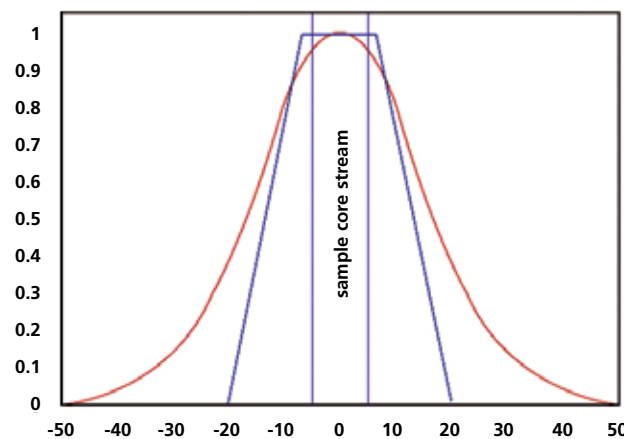

375-nm Near UV laser

The top hat design of the 375-nm Near UV laser modifies the usual Gaussian beam (in red) that illuminates a sample at higher intensity in the middle of the beam (in blue) and lower intensity at the edges. The composite “square” beam illuminates the middle and edges of the sample core stream at the same intensity. The “square” beam almost triples the amount of light at the sample intercept.



Trigon and octagon detector arrays

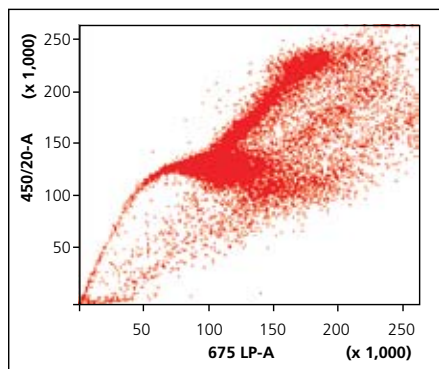

Mouse stem cell side population detection
 As a consequence of the even sample illumination, cells have a greatly improved coefficient of variation (CV).

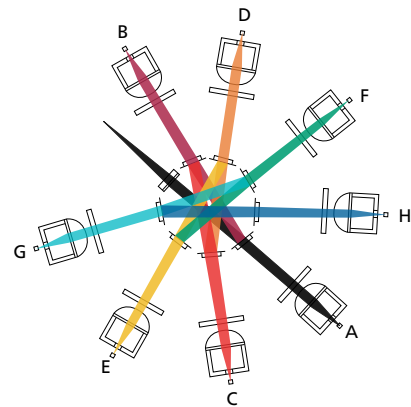

Transmission pathways in an octagon

Easy II Handle

The BD FACSAria II cell sorter places instrument setup, QC, sorting, and data management under the control of BD FACSDiva software so researchers can spend more time on experiments.

Compatibility with other BD analyzers and sorters makes it easier to move from analysis to cell sorting.

Digital electronics

The BD FACSAria II cell sorter uses digital electronics to acquire data at rates up to 70,000 events per second for up to 8 parameters, with linear results over a broad dynamic range.

Cytometer Setup and Tracking software

Enhancements to BD FACSDiva software include a new Cytometer Setup and Tracking (CS&T) feature that automates flow cytometer setup, adjusts for instrument variability, and establishes baseline settings. Chances of operator error are reduced, and results are more consistent.

The setup features let users define a configuration baseline and run a performance check. The software will then automatically set up the cytometer to this established baseline. To match the exact baseline, the CS&T software automatically adjusts for reproducible performance of the instrument. This ensures the greatest possible consistency from one day to the next, saves time, and improves reliability of experiment results. The software also allows for the creation of application-specific settings to allow for rapid performance of routine experiments in a more consistent manner.

Tracking capabilities in the software measure a number of instrument settings and report on performance. Levey-Jennings plots help users understand instrument performance and identify maintenance issues.

Fast startup to sort time

- 1 Turn on the sorter.
- 2 Start the fluidics.
- 3 Perform automated setup, QC, and drop delay optimization.
- 4 Optimize the sample.
- 5 Perform the sort.

ANALYSIS

BD Cytometer Setup and Tracking software

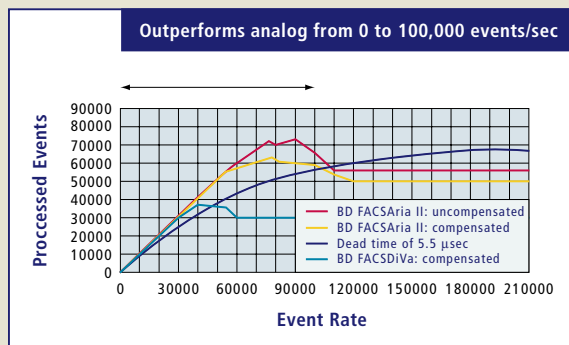

BD FACSAria II system acquisition rates

Ready **II** Deliver

BD Biosciences is fully committed to the success and satisfaction of its customers. The BD FACSAria II cell sorter is backed by a world-class service and support organization with unmatched flow cytometry experience.

Since 1974, BD has innovated flow cytometry for optimal performance, ease of use, and improved workflow. This expertise is made available to BD FACSAria II customers through comprehensive training, applications and technical support, and expert field service.

Training

Hands-on training is included with each BD FACSAria II cell sorter. In addition, training courses are held at BD training centers worldwide. BD flow cytometry training courses combine theory and practice to provide participants with the skills and experience they need to take full advantage of the capabilities of the BD FACSAria II cell sorter.

Technical application support

BD Biosciences technical applications support specialists are available to provide field- or phone-based assistance and advice. Expert in a diverse array of topics, BD technical application specialists are well equipped to address customer needs in both instrument and applications support.

Field service engineers

When instrument installation or service is required, a BD Biosciences Technical Field Service Engineer can be dispatched to the customer site. BD Biosciences field service engineers are located across the world. On-site service and maintenance agreements are available to provide long-term support for the BD FACSAria II.

Custom Services

Mobilizing technology for research applications requires close collaboration. The Custom Technology Team (CTT) at BD Biosciences works with customers to provide solutions through custom reagents, panels, or assay protocols.

Staffed by leading scientists with the breadth and depth of scientific and technical expertise, the CTT team will coordinate with researchers to study the problem at hand, make recommendations, and help implement the solutions. In this way, BD Biosciences technical know-how is translated into practical solutions that allow customers to focus on research.

Special Order Research Products

Instruments can be customized to meet customer requirements via the Special Order Research Products (SORP) programs.

Regional Offices bdbiosciences.com/offices

Asia Pacific
BD Singapore
Tel 65.6861.0633
Fax 65.6860.1593

Australia/New Zealand
Australia
Toll Free: 1800 656 100
Tel 61.2.8875.7000
Fax 61.2.8875.7200
bd_anz@bd.com
New Zealand
Toll Free: 0800 572.468
Tel 64.9.574.2468
Fax 64.9.574.2469
bd_anz@bd.com

Europe
BD Biosciences
Tel 32.2.400.98.95
Fax 32.2.401.70.94
help.biosciences@europe.bd.com

Canada
BD Biosciences
Toll Free 888.259.0187
Tel 905.542.8028
Fax 888.229.9918
canada@bd.com

Japan
Nippon Becton Dickinson
Toll Free 0120.8555.90
Tel 81.24.593.5405
Fax 81.24.593.5761

United States
BD Biosciences
Customer/Technical Service
Toll Free 877.232.8995
Bioimaging Systems
Fax 301.340.9775
Discovery Labware
Fax 978.901.7490
Immunocytometry Systems
Fax 800.325.9637
Pharming
Fax 800.325.9637
bdbiosciences.com

BD flow cytometers are Class I (1) laser products. © 2008 Becton, Dickinson and Company. All rights reserved. No part of this publication may be reproduced, transmitted, transcribed, stored in retrieval systems, or translated into any language or computer language, in any form or by any means: electronic, mechanical, magnetic, optical, chemical, manual, or otherwise, without prior written permission from BD Biosciences.

The Alexa Fluor®, Pacific Blue™, and Cascade Blue® dye antibody conjugates in this product are sold under license from Molecular Probes, Inc., for research use only, excluding use in combination with microarrays, or as analyte specific reagents. The Alexa Fluor® dyes (except for Alexa Fluor® 430), Pacific Blue™ dye, and Cascade Blue® dye are covered by pending and issued patents.

For research use only. Not for use in diagnostic or therapeutic procedures. Purchase does not include or carry any right to resell or transfer this product either as a stand-alone product or as a component of another product. Any use of this product other than the permitted use without the express written authorization of Becton Dickinson and Company is strictly prohibited. Product availability and prices are subject to change without notice.

BD, BD Logo and all other trademarks are property of Becton, Dickinson and Company. © 2008 BD

